

Model No.DHR242 24MM CORDLESS COMBI. HAMMER

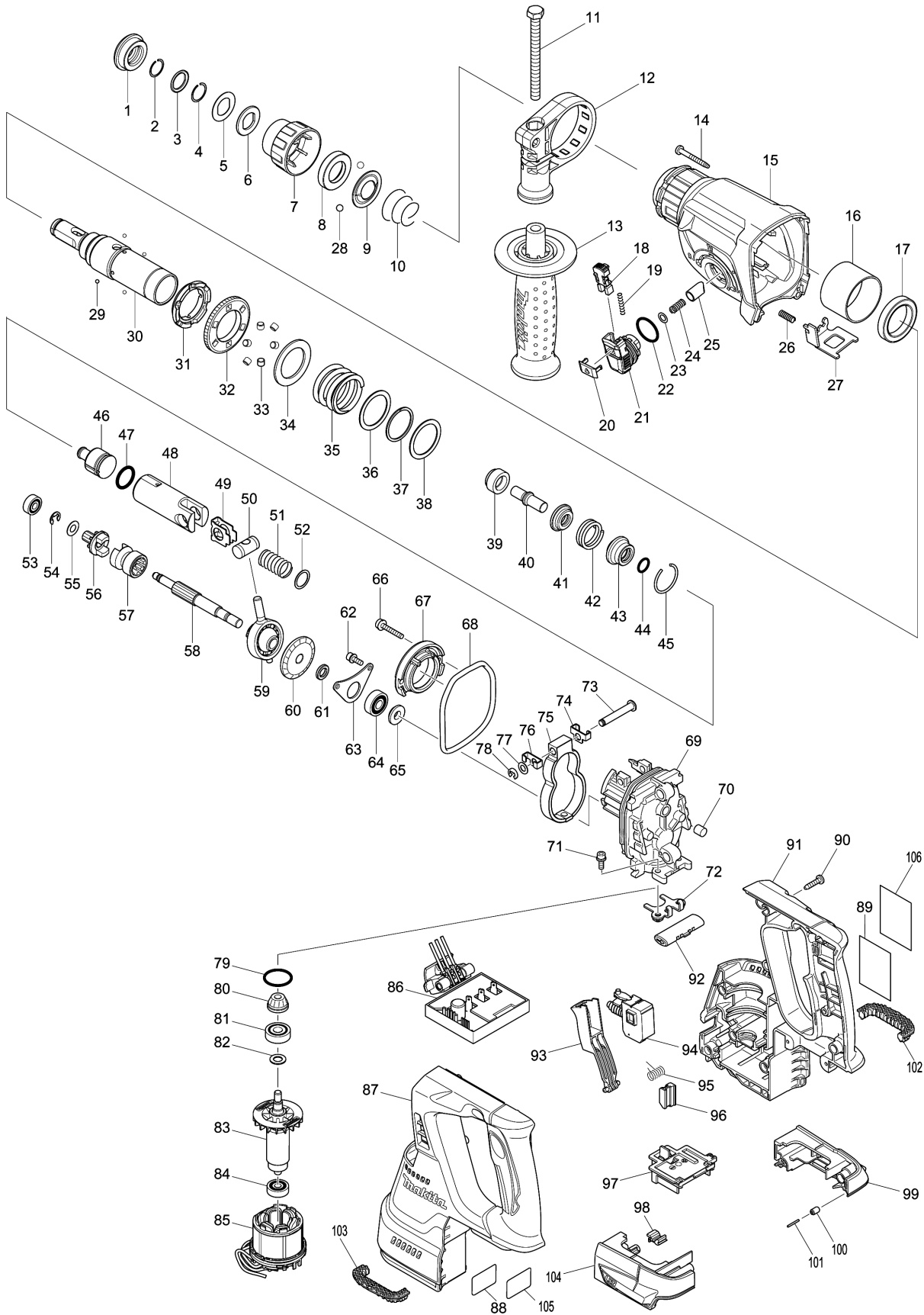

Model No.DHR242 24MM CORDLESS COMBI. HAMMER

รายการ	รหัสอะไหล่	รายละเอียด	การ แลกเปลี่ยน	จำนวน	New/Old	ขาย	ซื้อ	ข้อความ
001	286288-8	CAP 35		1				
002	233989-9	RING SPRING 14		1				
003	346221-3	WASHER 16		1				
004	233992-0	RING SPRING 15		1				
005	267437-6	FLAT WASHER 17		1				
006	424364-2	RUBBER WASHER 16		1				
007	451533-2	CHUCK COVER		1				
008	325813-1	RING 21		1				
009	346177-0	GUIDE WASHER		1				
010	233916-6	CONICAL COMP. SPRING 21-29		1				
011	266745-2	HEX.BOLT M8X90		1				
012	453129-5	GRIP BASE		1				
013	158057-6	GRIP 36 COMPLETE		1				
014	266351-3	TAPPING SCREW 4X35		4				
015	141229-0	GEAR HOUSING COMPLETE		1				
C10	213345-9	OIL SEAL 25		1				
C20	890903-4	INDICATION LABEL		1				
016	331890-3	CUP SLEEVE		1				
017	211294-4	BALL BEARING 6806LLU		1				
018	454112-5	LOCK BUTTON		1				
019	234264-6	COMPRESSION SPRING 3		1				
020	453131-8	CHANGE LEVER COVER		1				
021	453125-3	CHANGE LEVER		1				
022	213381-5	O RING 21		1				
023	253308-3	THIN WASHER 6		1				
024	234147-0	COMPRESSION SPRING 5		1				
025	325785-0	PUSH CORN		1	*			
025-1	326850-8	PUSH CORN	S	1				
026	233360-7	COMPRESSION SPRING 4		1				
027	346537-6	LOCK PLATE		1				
028	216022-2	STEEL BALL 7.0		2				
029	216019-1	STEEL BALL 3		4				
030	140265-3	TOOL HOLDER COMPLETE		1				
031	313149-0	DRIVING FLANGE		1	*			
031-1	332139-4	DRIVING FLANGE	S	1				
032	227232-6	SPUR GEAR 51		1	*			
032-1	227360-7	SPUR GEAR 51	S	1				
033	268226-2	PIN 6		6	*			
034	267414-8	FLAT WASHER 30		1	*			
035	234148-8	COMPRESSION SPRING 31		1				

Please order the parts with part number.

Print Date 16/8/2021

Model No.DHR242 24MM CORDLESS COMBI. HAMMER

รายการ	รหัสอะไหล่	รายละเอียด	การ แล็ก เปลี่ยน	จำนวน	New/Old	ขาย	ซื้อ	ข้อความ
036	267153-0	FLAT WASHER 30		1				
037	257932-4	SPIRO LOCK WASHER 30		1				
038	267153-0	FLAT WASHER 30		1				
039	325783-4	SLEEVE 9B		1				
040	325789-2	IMPACT BOLT A		1				
041	325792-3	WASHER 10		1				
042	234149-6	COMPRESSION SPRING 20		1				
043	325793-1	O-RING CASE B		1				
044	213073-6	O RING 9		1				
045	233979-2	RING SPRING 28		1				
046	326139-4	STRIKER		1				
047	213258-4	O RING 17.5		1				
048	310345-1	PISTON CYLINDER		1				
049	346036-8	GUIDE PLATE		1				
050	324215-8	PISTON JOINT		1				
051	234098-7	COMPRESSION SPRING 14		1				
052	267447-3	FLAT WASHER 14		1				
053	211012-0	BALL BEARING 606ZZ		1				
054	257336-0	STOP RING EXT U-6		1				
055	253186-1	FLAT WASHER 7		1				
056	227231-8	SPUR GEAR 10		1				
057	331814-9	CLUTCH CAM A		1	*			
057-1	326849-3	CLUTCH CAM A	S	1				
058	326140-9	CAM SHAFT		1				
059	219020-5	SWASH BEARING 10		1				
060	227588-7	SPIRAL BEVEL GEAR 32		1				
061	257323-9	RING 8		1				
062	922118-6	HEX. SOCKET HEAD BOLT M4X12		2				
063	346038-4	BEARING RETAINER B		1				
064	211032-4	BALL BEARING 608ZZ		1				
065	324212-4	RING 8		1				
066	922147-9	HEX. SOCKET HEAD BOLT M4X25		2				
067	141230-5	INNER SUPPORT COMPLETE		1				
068	213767-3	O-RING 75		1				
069	318810-4	INNER HOUSING		1				
070	443153-6	FELT		1				
071	922118-6	HEX. SOCKET HEAD BOLT M4X12		2				
072	346536-8	BEARING RETAINER A		1				
073	256536-9	FLAT FILLISTER HD PIN 6		1				

Please order the parts with part number.

Print Date 16/8/2021

Model No.DHR242 24MM CORDLESS COMBI. HAMMER

รายการ	รหัสอะไหล่	รายละเอียด	การ แลกเปลี่ยน	จำนวน	New/Old	ขาย	ซื้อ	ข้อความ
074	346538-4	WEIGHT HOLDER GUIDE		1				
075	313224-2	COUNTER WEIGHT		1				
076	346538-4	WEIGHT HOLDER GUIDE		1				
077	253726-5	FLAT WASHER 6		1				
078	961018-5	STOP RING E-5		1				
079	213008-7	O RING 22.4		1				
080	141458-5	SPIRAL BEVEL GEAR 11 COMPLETE		1				
081	210024-0	BALL BEARING 608LLU		1				
082	253835-0	FLAT WASHER 8		1				
083	619293-4	ROTOR		1				
084	210022-4	BALL BEARING 626DDW		1				
085	629922-1	STATOR		1	*			
085-1	529922-0	STATOR ASS'Y	<	1	*			
085-2	529187-4	STATOR ASS'Y	S	1				
086	620241-8	CONTROLLER		1				
087	187687-6	HOUSING SET		1	*			
D10		INC. 91			*			
087-1	183A34-5	HOUSING SET	<	1	*			
D10		INC. 91			*			
087-2	183C02-0	HOUSING SET	S	1	*			
D10		INC. 91			*			
087-3	183C02-0	HOUSING SET	O	1				
D10		INC. 91						
088	815B57-8	DHR242 SERIAL NO. LABEL		1				
089	815A38-6	DHR242 NAME PLATE		1				
090	266326-2	TAPPING SCREW 4X18		10	*			
090-1	266326-2	TAPPING SCREW 4X18	O	10				
091	187687-6	HOUSING SET		1	*			
D10		INC. 87			*			
091-1	183A34-5	HOUSING SET	<	1	*			
D10		INC. 87			*			
091-2	183C02-0	HOUSING SET	S	1	*			
D10		INC. 87			*			
091-3	183C02-0	HOUSING SET	O	1				
D10		INC. 87						
092	453124-5	F/R CHANGE LEVER		1				
093	453123-7	SWITCH LEVER		1				
094	650709-0	SWITCH C3JW-1A-P		1				
095	233598-4	TORSION SPRING 6		1				
096	313226-8	OPENER		1				

Please order the parts with part number.

Print Date 16/8/2021

Model No.DHR242 24MM CORDLESS COMBI. HAMMER

รายการ	รหัสอะไหล่	รายละเอียด	การ แลกเปลี่ยน	จำนวน	New/Old	ขาย	ซื้อ	ข้อความ
097	644808-8	TERMINAL		1				
098	424476-1	CUSHION		1				
099	187377-1	BATTERY HOUSING SET		1				
C10	263005-3	RUBBER PIN 6		2				
D10		INC. 104						
100	263036-2	RUBBER PIN 5		1				
101	268184-2	PIN 1.5		1				
102	424473-7	CUSHION RUBBER		1				
103	424473-7	CUSHION RUBBER		1				
104	187377-1	BATTERY HOUSING SET		1				
C10	263005-3	RUBBER PIN 6		2				
D10		INC. 99						
105	893072-0	CLEAR LABEL		1				
106	890994-5	CLEAR LABEL		1				
107	424734-5	SPONGE	S	2				
A01	324219-0	DEPTH GAUGE		1				
A02C	***DC18RC	DC18RC FAST CHARGER		1				
A03C	196015-4	BATTERY BL1830 SET		2	*			
A03-1C	196015-4	BATTERY BL1830 SET	O	2	*			
A03-2C	197600-6	BATTERY BL1830B SET	<	2	*			
A03-3C	199283-8	BATTERY BL1830B SET	<	2	*			
A03-4C	199283-8	BATTERY BL1830B SET	<	2				
A04C	450128-8	BATTERY COVER		1				
A05C	141401-4	PLASTIC CASE COMPLETE		1				
C10	162271-8	LATCH		2				
C20	890904-2	INDICATION LABEL		1				
A06C	802L23-4	DHR242RFE PLASTIC CASE LABEL		2	*			
A06-1C	802L12-9	DHR242RFE PLASTIC CASE LABEL	<	2				
B01	195833-7	HAMMER SERVICE KIT		1				
C10	195127-0	OIL VESSEL SET		2				
D10		INC. 1,2,4,6,28,44,45,47						

Please order the parts with part number.

Print Date 16/8/2021